

# Alarm Interface Box (AIB)

Product No. PAS-623-AIB

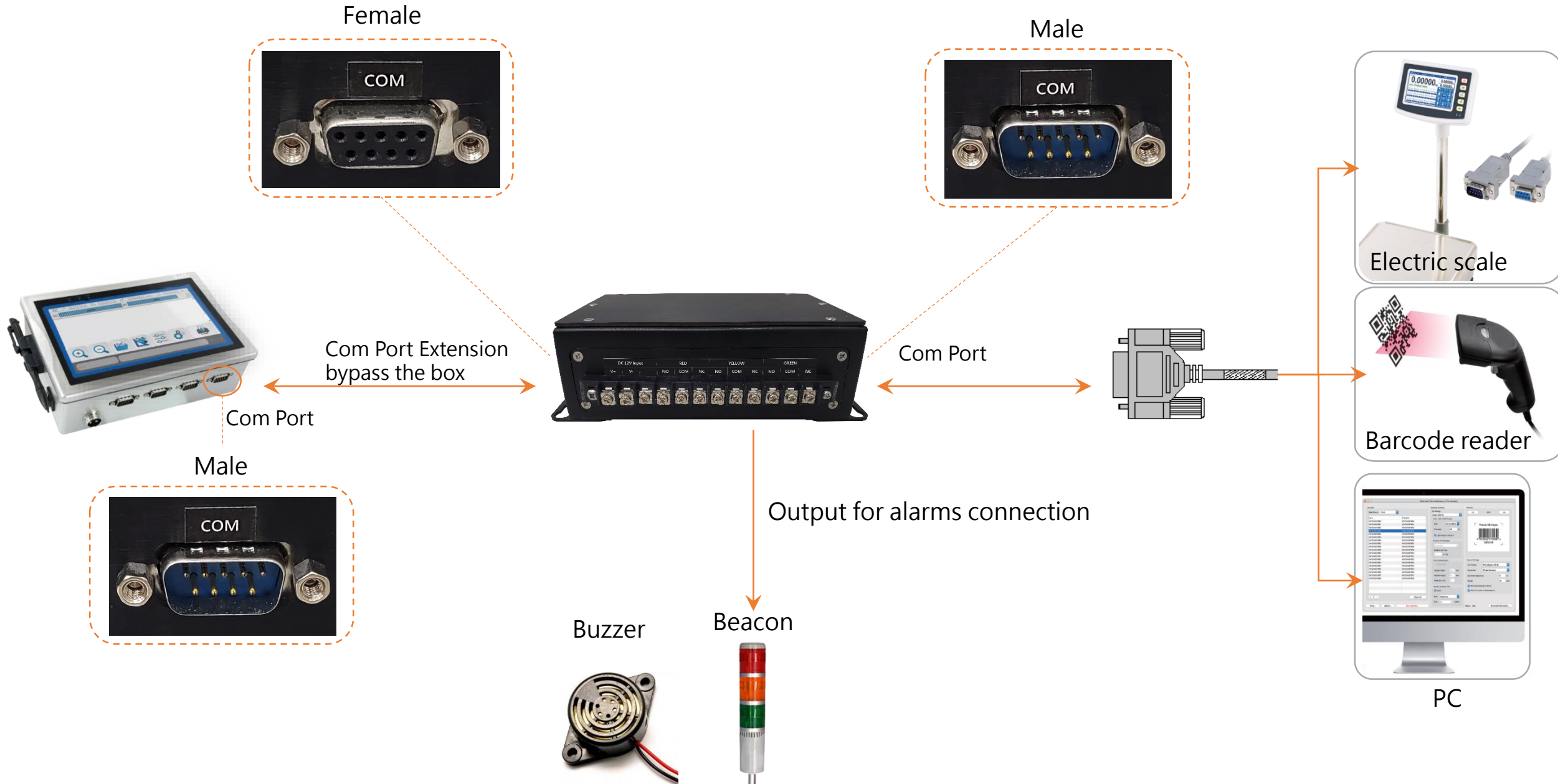

# Summary



# Pinouts

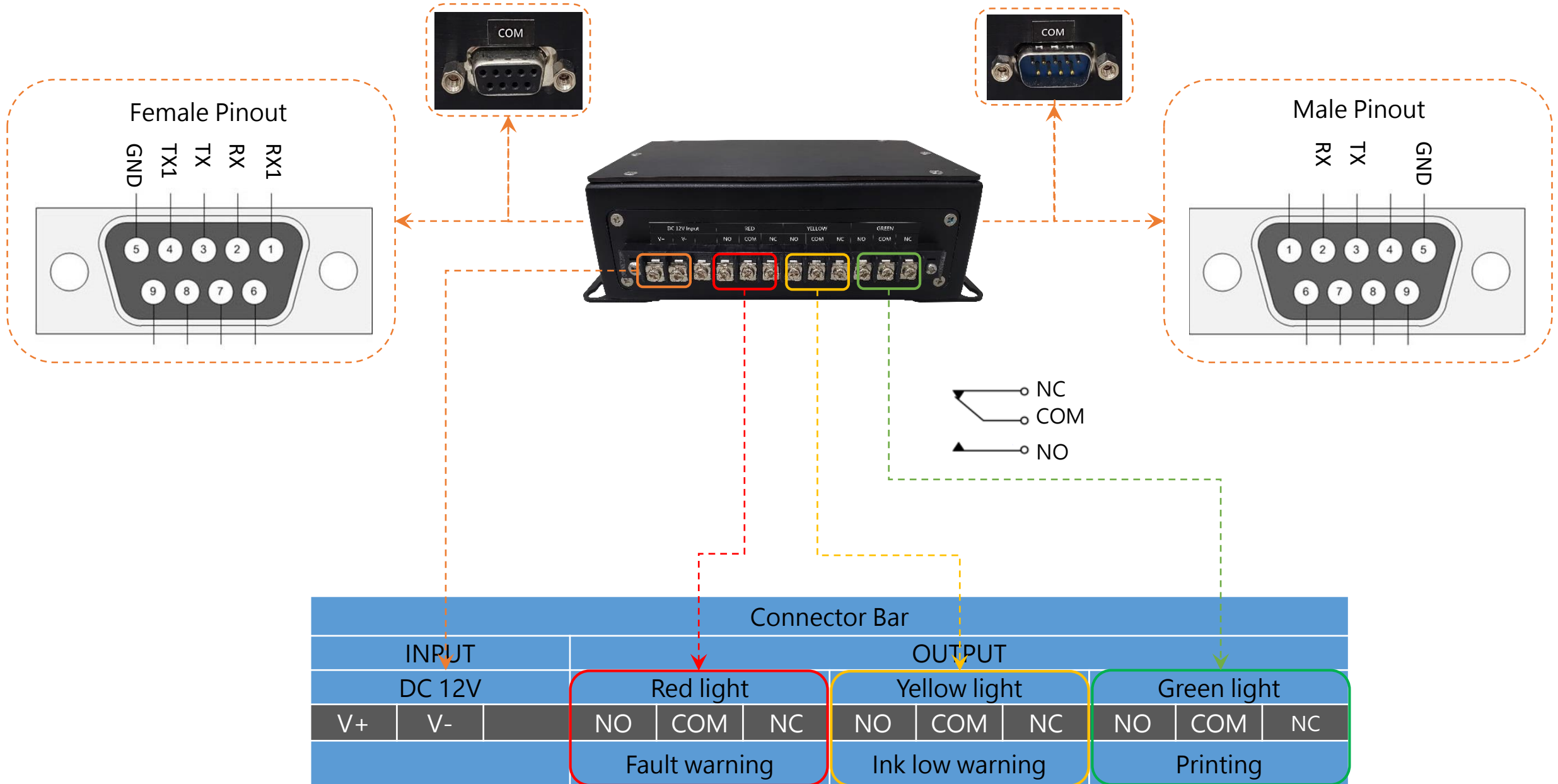

# Illustration - Device connection

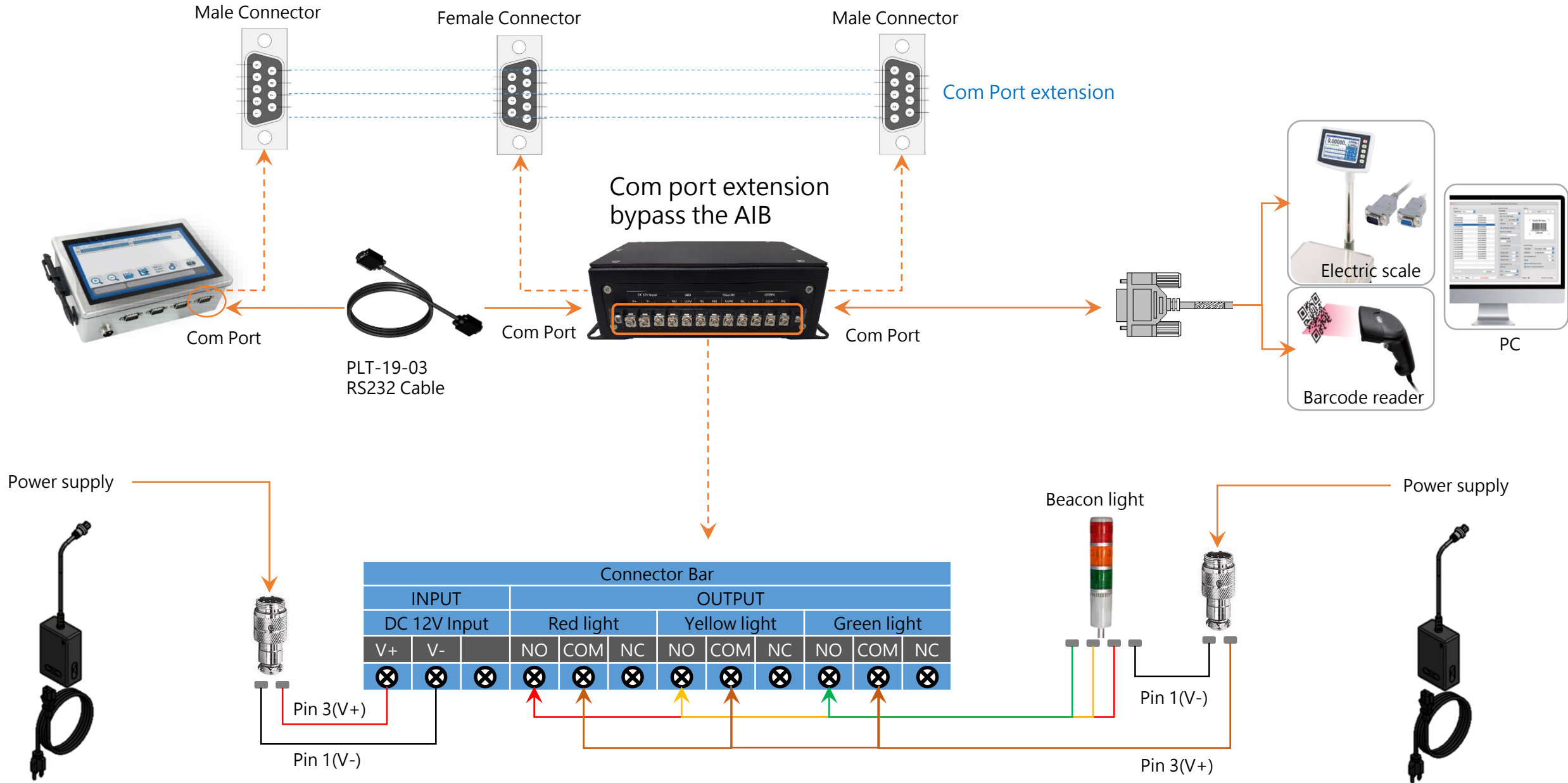



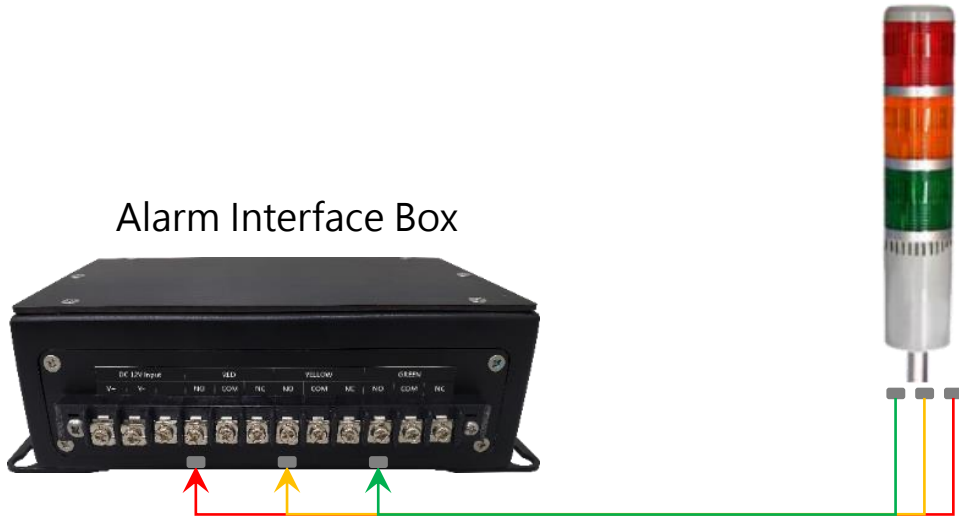

# Lights indication illustration

Beacon light

Alarm Interface Box



Lights Indication	Description
	No printing
	Fault warning
	Ink low warning
	Printing
	Printing with ink low warning

# Controller Setting

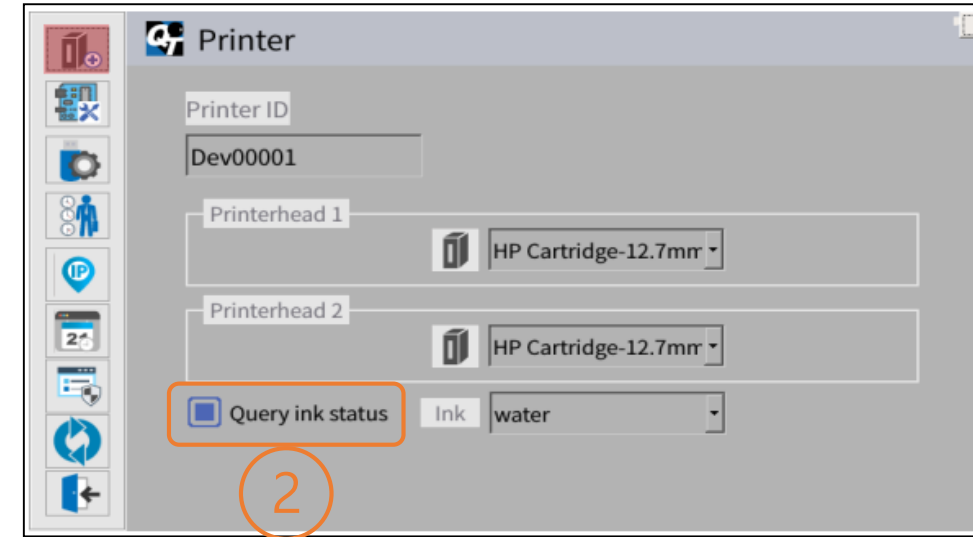
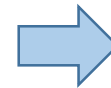
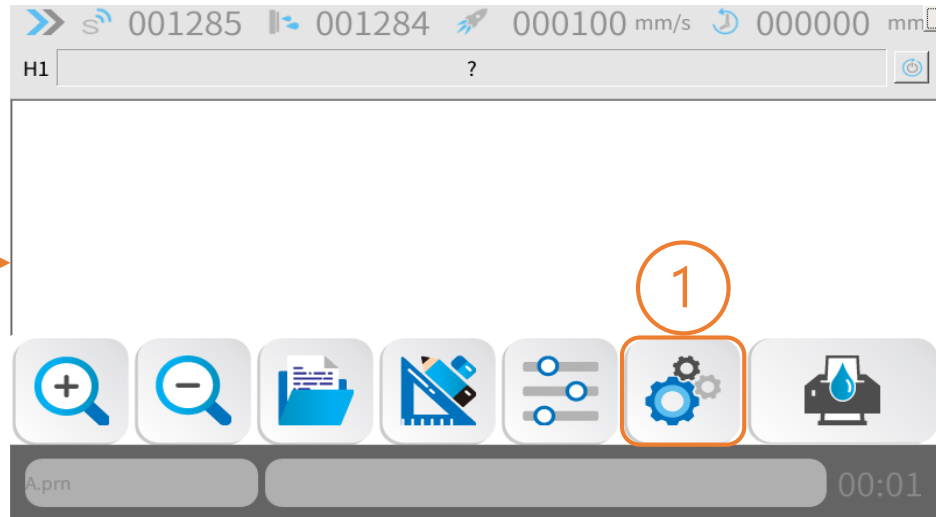

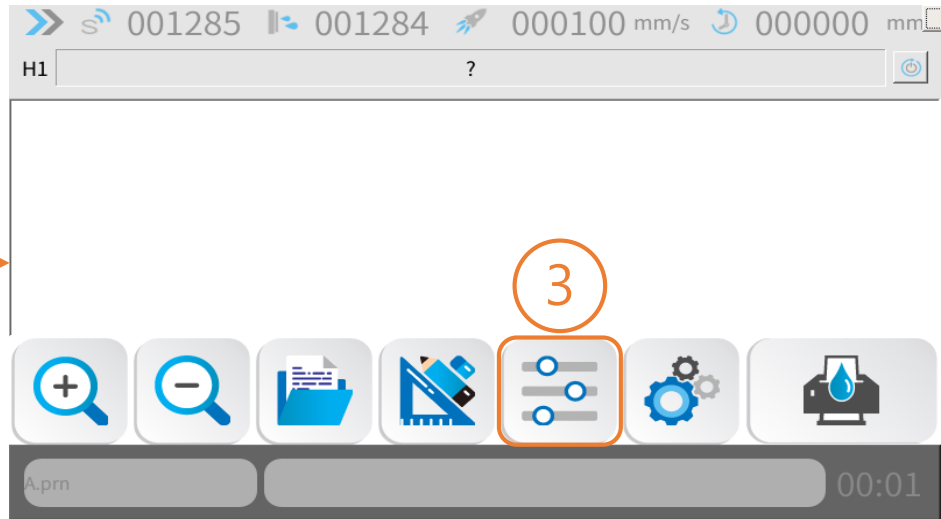

# Controller Setting

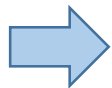
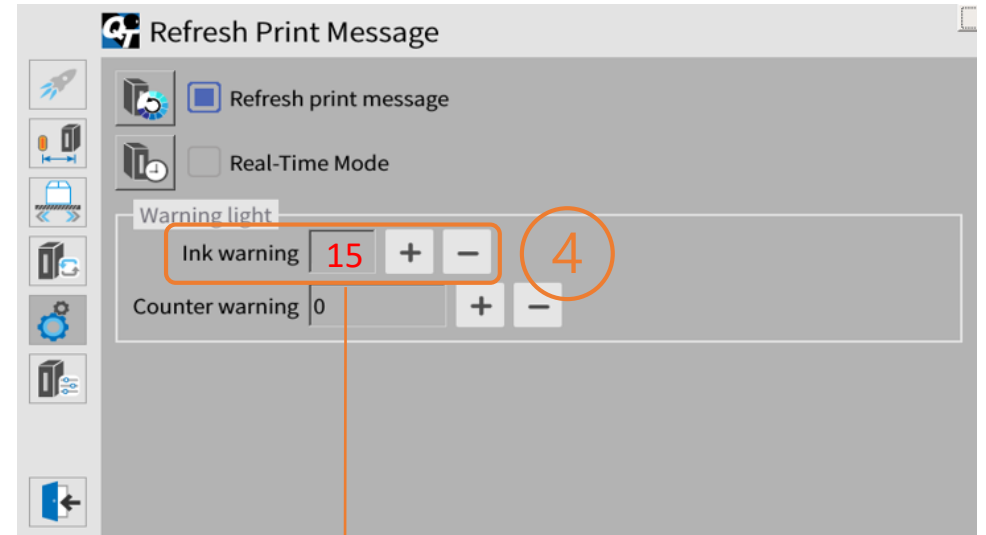

Ink warning :

Set up at 【 15 】 , it represents the printer will goes off alarm at ink remain less than 15%.

# Required Parts

PAS-623-AIB  
Trigger / Encoder signal Hub



Power connector is accessorized in the AIB

PLT-19-03  
RS232 Cable



FSP040-RHAN2-3P  
Power supply for Alarm Interface Box

Power cord  
PE-22-23 ; **Note for the plug style in order is needed**

DJ4510-700-45  
Beacon light



Power connector is accessorized in the beacon light



FSP040-RHAN2-3P  
Power supply for beacon light

Power cord  
PE-22-23 ; **Note for the plug style in order is needed**